

## Protistor® Square-body Fuses PSC aR sizes 7x - 650 V to 1300 VAC Main characteristics

 Recognized

### 650 to 1300VAC / 63 to 2800A.

- Exceptionally low I<sup>2</sup>T, Watt losses.
- Non-magnetic construction, highly reliable low voltage.
- Indicator system.
- Conformity to UL, CSA investigated, IEC, DIN and VDE standards.
- Increased technical performance
- Higher ratings.
- Reduction in volume and weight.
- This fuse preselection table indicates, for each size:
  - rated current (or rating) I<sub>n</sub>
  - pre-arcing I<sup>2</sup>t (I<sup>2</sup>t<sub>p</sub>) at 1 ms
  - total operating I<sup>2</sup>t (I<sup>2</sup>t<sub>t</sub>) at 1000 V and 850V(I)f=50Hz, cos φ =0.15, and for a total operating time from 8 to 10 ms
  - dissipated power P<sub>n</sub> at the rated current I<sub>n</sub>, and at 0.8 I<sub>n</sub>, in steady state
  - breaking capacity at various voltages, checked by tests made in accordance with IEC and American standards.



Estimated breaking capacity: 300 kA

### PSC 650 to 1300VAC US and European standard

Size	Nominal Voltage U <sub>N</sub> (VAC)		Ampere Rating (A)	Pre-arcing I <sup>2</sup> t @ 1ms (kA <sup>2</sup> s)	Total I <sup>2</sup> t @ 1000V (*) @ U <sub>n</sub> (kA <sup>2</sup> s)	Power (W)		Tested Breaking capacity		
	IEC	UL				End contacts	Blades	IEC	USA	
70	1250	1300	50	0,116	0,7	16	16	100kA @ 1250V	100kA @ 1300V	
			63	0,210	1,2	26	26			
			80	0,470	2,7	27	27			
			100	0,830	4,8	30	30			
			125	1,30	7,5	38	38			
			160	2,55	15	45	45			
	1200	1300	200	4,7	27	54	56	100kA @ 1200V	100kA @ 1300V	
			250	9,6	55	58	61			
			280	14	82	61	64			
			315	20	115	66	72			
			350	28	158	68	75			
			400	39	224	81	90			
1100	1200	450	62	356	82	82	150kA @ 1100V	150kA @ 1200V		
		500	84	483	83	83				
		800	900	550	128	576(*)			83	83
750	800	550	128	576(*)	83	83	100kA @ 800V	100kA @ 900V		
		630	176	730(*)	91	91	100kA @ 750V	100kA @ 800V		
		160	2,6	15	46	46	100kA @ 1250V	100kA @ 1300V		
1250	1300	200	4,7	27	54	54				
		250	8,9	51	61	61				
		280	12	68	68	70				
		315	16	92	73	76				
		350	22	127	76	80				
		400	38	220	76	80				
1100	1300 (TTI)	450	47	270	87	95			150kA @ 1100V	150kA @ 1200V
		500	68	390	90	X				
		500	68	390	X	100				
		550	84	485	98	112				
		630	125	725	105	X				
		630	125	725	X	120				
1000	1100	700	180	1040	105	105	150kA @ 1000V	150kA @ 1100V		
		900	950	800	290	1540(*)	116	116	100kA @ 900V	100kA @ 950V
		800	850	900	446	2010(*)	120	120	100kA @ 800V	100kA @ 850V

(<sup>1</sup>) at 850 V

(<sup>2</sup>) does not exist with blades



## Protistor® Square-body Fuses PSC aR sizes 7x - 650 V to 1300 VAC Main characteristics

### PSC 650 to 1300VAC US and European standard

Size	Nominal Voltage U <sub>N</sub> (VAC)		Ampere Rating (A)	Pre-arcing I <sub>pt</sub> @ 1ms (kA <sub>2s</sub> )	Total I <sup>2</sup> t @ 1000V (*) @ U <sub>N</sub> (kA <sub>2s</sub> )	Power (W)		Tested Breaking capacity Estimated B.C 300 kA	
	IEC	UL				End contacts	Blades	IEC	USA
72	1250	1300	280	10	60	72	72	100kA @ 1250V	100kA @ 1300V
			315	15	87	76	76		
			350	21	120	77	77		
			400	32,5	190	80	80		
			450	44	255	87	89		
			500	57	330	94	98		
	550	68	390	110	120				
	630	105	610	113	X				
	1100	1200	630	105	610	X	125	150kA @ 1100V	150kA @ 1200V
			700	145	815	122	140		
			800	215	1240	125	146		
	1000	1100	700	145	815	X	140	150kA @ 1000V	150kA @ 1100V
800			215	1240	X	146			
900			312	1800	130	152			
850	900	1000	439	2150(*)	136	136	100kA @ 850V	100kA @ 900V	
73	1250	1300	315	12	68	84	84	100kA @ 1250V	100kA @ 1300V
			350	17	100	86	86		
			375	19	110				
			400	25	145	93	93		
			450	35,5	205	99	100		
			500	44	255	110	112		
			550	57	330	116	120		
			630	84	485	125	132		
			700	110	640	135	X		
			800	190	1090	136	X		
	1200	1300	700	110	640	X	146	100kA @ 1200V	100kA @ 1300V
			900	250	1090	150	X		
			800	190	1090	X	148	150kA @ 1100V	150kA @ 1200V
	1100	1200	900	250	1440	X	170	150kA @ 1000V	150kA @ 1100V
			1000	370	2130	152	168		
	1000	1100	1100	445	2555	168	208		
			950	445	2430(*)	168	X	150kA @ 950V	150kA @ 1000V
	900	1000	1000	370	1920(*)	X	174	150kA @ 900V	150kA @ 1000V
			1100	445	2280(*)	X	208		
			1250	585	3080(*)	186	X		
1400	1000	1400	755	4100(*)	210	X			
		850	755	3700(*)	210	X	150kA @ 850V	150kA @ 900V	
690	700	1500	1180	4750(*)	200	X	180kA @ 690V	180kA @ 700V	
		1600	1430	5740(*)	203	X			
600	650	1800	2040	7150(*)	206	X	120kA @ 600V	120kA @ 650V	
2 x 72	1250	1300	630	60	348	160		100kA @ 1250V	
			700	84	480	162			
			800	130	760	168			
			900	176	1020	183			
			1000	228	1320	197			
			1100	272	1560	231			
	1100	1200	1250	426	2440	237		100kA @ 1100V	
			1400	568	3260	256			
			1600	860	4895	262		100kA @ 1000V	
	1000	1100	1800	1250	6350(*)	275		100kA @ 900V	
			2000	1760	7570(*)	285		100kA @ 750V	
	900	1000	2200	2410	8350(*)	320		100kA @ 650V	
2500			3470	12000(*)	340				
2 x 73	1250	1300	800	100	580	195		100kA @ 1250V	
			900	142	820	208			
			1000	176	1000	231			
			1100	228	1300	244			
			1250	336	1900	262			
			1400	440	2600	283			
	1100	1200	1600	760	4400	286		100kA @ 1100V	
			1800	1000	5800	315			
			2000	1480	8500	319		120kA @ 1000V	
	1000	1100	2200	1780	9632(*)	353		100kA @ 950V	
			2500	2340	12075(*)	390		110kA @ 900V	
	900	1000	2800	3000	15000(*)	440		100kA @ 850V	
3000			4980	15700(*)	405				
850	900	3200	5720	19030(*)	426		200kA @ 600V		
		3600	8160	25200(*)	430		200kA @ 550V		

(1) at 850 V

(2) does not exist with blades

## Protistor® Square-body Fuses PSC aR sizes 7x - 650 V to 1300 VAC IEC Terminals - French 70 - 73 End contacts

Size	Designation	Reference Number	Weight (g)	Packaging	Catalog Number			
70	12,5 URD 70 TT F 0050	C301095	350	3	PC70UD13C50TF			
	12,5 URD 70 TT F 0063	M300483			PC70UD13C63TF			
	12,5 URD 70 TT F 0080	N300484			PC70UD13C80TF			
	12,5 URD 70 TT F 0100	P300485			PC70UD13C100TF			
	12,5 URD 70 TT F 0125	Q300486			PC70UD13C125TF			
	12,5 URD 70 TT F 0160	R300487			PC70UD13C160TF			
	12,5 URD 70 TT F 0200	S300488			PC70UD13C200TF			
	12,5 URD 70 TT F 0250	T300489			PC70UD13C250TF			
	12 URD 70 TT F 0280	N300714			PC70UD12C280TF			
	12 URD 70 TT F 0315	V300490			PC70UD12C315TF			
	11 URD 70 TT F 0350	W300491			PC70UD11C350TF			
	11 URD 70 TT F 0400	E300867			PC70UD11C400TF			
	11 URD 70 TT F 0450	H301284			PC70UD11C450TF			
	10 URD 70 TT F 0500	J301285			PC70UD11C500TF			
	8 URD 70 TT F 0550	K301286			PC70UD80V550TF			
	71	12,5 URD 71 TT F 0160			B300749	520	3	PC71UD13C160TF
12,5 URD 71 TT F 0200		Z300517	PC71UD13C200TF					
12,5 URD 71 TT F 0250		A300518	PC71UD13C250TF					
12,5 URD 71 TT F 0280		P300715	PC71UD13C280TF					
12,5 URD 71 TT F 0315		B300519	PC71UD13C315TF					
12,5 URD 71 TT F 0350		C300520	PC71UD13C350TF					
12,5 URD 71 TT F 0400		D300521	PC71UD13C400TF					
12,5 URD 71 TT F 0450		E300522	PC71UD13C450TF					
11 URD 71 TT F 0500		F300523	PC71UD11C500TF					
11 URD 71 TT F 0550		G300524	PC71UD11C550TF					
11 URD 71 TT F 0630		H300525	PC71UD11C630TF					
10 URD 71 TT F 0700		M301288	PC71UD10C700TF					
9 URD 71 TT F 0800		Z300862	PC71UD90V800TF					
8 URD 71 TT F 0900		N301289	PC71UD80VC900TF					
72		12,5 URD 72 TT F 0250	X301573	800	3			PC72UD13C250TF
		12,5 URD 72 TT F 0280	Y300493					PC72UD13C280TF
	12,5 URD 72 TT F 0315	Z300494	PC72UD13C315TF					
	12,5 URD 72 TT F 0350	A300495	PC72UD13C350TF					
	12,5 URD 72 TT F 0400	B300496	PC72UD13C400TF					
	12,5 URD 72 TT F 0450	C300497	PC72UD13C450TF					
	12,5 URD 72 TT F 0500	D300498	PC72UD13C500TF					
	12,5 URD 72 TT F 0550	E300499	PC72UD13C550TF					
	12,5 URD 72 TT F 0630	F300500	PC72UD13C630TF					
	11 URD 72 TT F 0700**	G300501	PC72UD11C700TF					
	11 URD 72 TT F 0800**	H300502	PC72UD11C800TF					
	10 URD 72 TT F 0900**	G300869	PC72UD10C900TF					
	8,5 URD 72 TT F 1000**	T301294	PC72UD85V1000TF					
	73	12,5 URD 73 TT F 0315	J300503			1250	1	PC73UD13C315TF
		12,5 URD 73 TT F 0350	K300504					PC73UD13C350TF
		12,5 URD 73 TT F 0400	L300505					PC73UD13C400TF
12,5 URD 73 TT F 0450		M300506	PC73UD13C450TF					
12,5 URD 73 TT F 0500		N300507	PC73UD13C500TF					
12,5 URD 73 TT F 0550		P300508	PC73UD13C550TF					
12,5 URD 73 TT F 0630		Q300509	PC73UD13C630TF					
12,5 URD 73 TT F 0700		R300510	PC73UD13C700TF					
12,5 URD 73 TT F 0800		S300511	PC73UD13C800TF					
12 URD 73 TT F 0900**		T300512	PC73UD12C900TF					
10 URD 73 TT F 1000**		V300513	PC73UD10C1000TF					
9,5 URD 73 TT F 1100**		W300514	PC73UD95V800TFB					
9 URD 73 TT F 1250**		T300696	PC73UD90V13CTF					
8,5 URD 73 TT F 1400**		S300718	PC73UD85C14CTF					
6,9 URD 73 TT F 1600**		B301301	PC73UD69V16CTF					
6 URD 73 TT F 1800**		C301302	PC73UD60V18CTF					

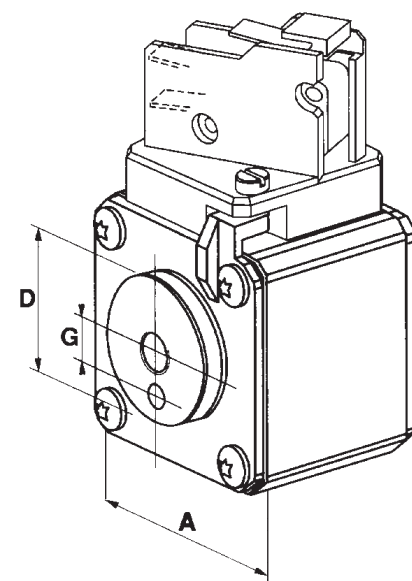
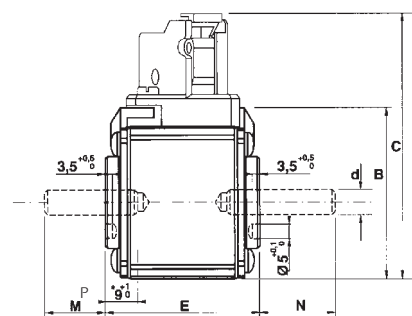

Microswitches and threaded studs supplied separately

**Note:**  
Dimensions in mm  
Dimensions in inches

Size	A	B	C	D	M*	N*	E±1	d	G±0.1	P±0.1
70	40	46,5	82	26	22	27	74	M8	9	6
	1-9/16"	1-27/32"	3-7/32"	1-1/64"			2-29/32"		23/64"	15/64"
71	51	56,5	91	30	19	24	74	M8	9	9
	2"	2-7/32"	3-37/64"	1-3/16"			2-29/32"		23/64"	23/64"
72	60	65,5	100	38 ; (42mm **)	19	39	74	M10	15	9
	2-3/8"	2-37/64"	3-15/16"	1-1/2" ; (1-21/32" **)			2-29/32"		19/32"	23/64"
73	74,5	79,5	114	46 ; (52mm **)	24	39	74	M12	15	9
	2-15/16"	3-1/8"	4-1/2"	1-13/16" ; (2-1/16" **)			2-29/32"		19/32"	23/64"



## Protistor® Square-body Fuses

PSC aR sizes 7x - 650 V to 1300 VAC

IEC Terminals - French 272 - 273 End contacts

Size	Designation	Reference Number	Weight (g)	Packaging	Catalog Number
73	12,5 URD 73 PPAF 0315	H300640	1250	1	PC73UD13C315PP4
	12,5 URD 73 PPAF 0350	J300641			PC73UD13C350PP4
	12,5 URD 73 PPAF 0400	K300642			PC73UD13C405PP4
	12,5 URD 73 PPAF 0450	L300643			PC73UD13C450PP4
	12,5 URD 73 PPAF 0500	M300644			PC73UD13C500PP4
	12,5 URD 73 PPAF 0550	N300645			PC73UD13C550PP4
	12,5 URD 73 PPAF 0630	P300646			PC73UD13C630PP4
	12,5 URD 73 PPAF 0700	Q300647			PC73UD13C700PP4
	12,5 URD 73 PPAF 0800	R300648			PC73UD13C800PP4
	12 URD 73 PPAF 0900	S300649			PC73UD12C900PP4
	10 URD 73 PPAF 1000	T300650			PC73UD10C10CPP4
	9,5 URD 73 PPAF 1100	V300651			PC73UD95V11CPP4
	9 URD 73 PPAF 1250	T300719			PC73UD90V13CPP4
8,5 URD 73 PPAF 1400	V300720	PC73UD85V14CPP4			
2 x 72	12,5 URD 272 TTF 0630	W300721	1900	1	PC272UD13C630TTF
	12,5 URD 272 TTF 0700	X300722			PC272UD13C700TTF
	12,5 URD 272 TTF 0800	Y300723			PC272UD13C800TTF
	12,5 URD 272 TTF 0900	Z300724			PC272UD13C900TTF
	12,5 URD 272 TTF 1000	A300725			PC272UD13C10CTF
	12,5 URD 272 TTF 1100	B300726			PC272UD13C11CTF
	11 URD 272 TTF 1250	M302231			PC272UD11C13CTF
	11 URD 272 TTF 1400	D300728			PC272UD11C14CTF
	10 URD 272 TTF 1600	L302230			PC272UD10C16CTF
	9 URD 272 TTF 1800	E301994			PC272UD90V18CTF
	7,5 URD 272 TTF 2000	F301995			PC272UD75V20CTF
	6,5 URD 272 TTF 2200	G301996			PC272UD65V22CTF
	6,5 URD 272 TTF 2500	H301997			PC272UD65V25CTF
2 x 73	12,5 URD 273 TTF 0800	F300730	2600	1	PC273UD13C800TTF
	12,5 URD 273 TTF 0900	G300731			PC273UD13C900TTF
	12,5 URD 273 TTF 1000	H300732			PC273UD13C10CTF
	12,5 URD 273 TTF 1100	J300733			PC273UD13C11CTF
	12,5 URD 273 TTF 1250	K300734			PC273UD13C13CTF
	11 URD 273 TTF 1400	K302229			PC273UD11C14CTF
	11 URD 273 TTF 1600	J302228			PC273UD11C16CTF
	11 URD 273 TTF 1800	S302236			PC273UD11C18CTF
	10 URD 273 TTF 2000	P300738			PC273UD10C20CTF
	9,5 URD 273 TTF 2200	Q300739			PC273UD95V22CTF
	9,5 URD 273 PLAF 2200	M301909			PC76UD95V22CP11
	9 URD 273 PLAF 2500	R300740			PC76UD90V25CP11
	8,5 URD 273 PLAF 2800	S300741			PC76UD85V28CP11
6 URD 273 PLAF 3000	K301999	PC76UD60V30CP11			
6 URD 273 PLAF 3200	M302001	PC76UD60V32CP11			
5,5 URD 273 PLAF 3600	N302002	PC76UD55V36CP11			

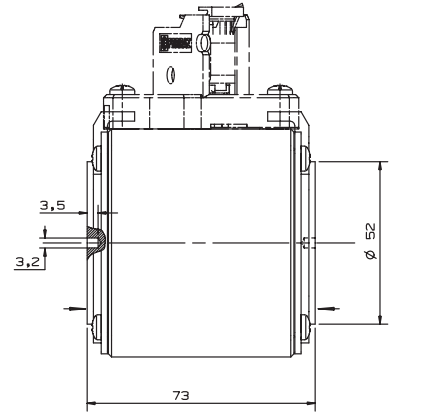

73 PPAF

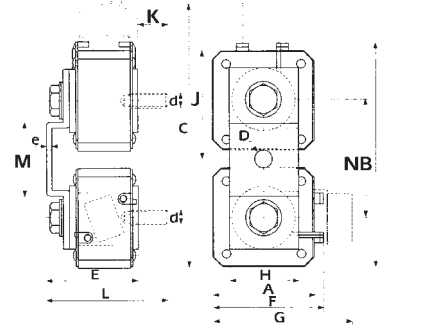

272 & 273 TTF

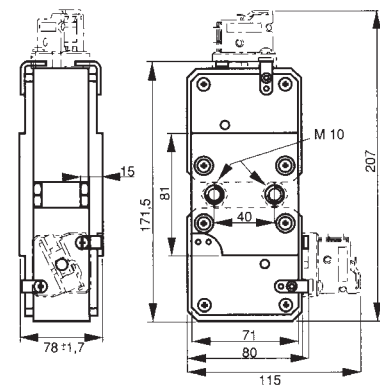

273 PLAF

Microswitches and threaded studs supplied separately

	A	B	C	D	E	F	G	H	J	K	d	e	L	M	N
2 x 72 TTF	60	138,5	172	11	91	65,5	100	35	66	39	M 10	4	131	48	72
2 x 73 TTF	74,5	167	200	13	91	79,5	114	50	80	39	M 12	4	131	54	86

**Note:**

Dimensions in mm

## Protistor® Square-body Fuses PSC aR sizes 7x - 650 V to 1300 VAC Curves set

### Multiplier coefficient

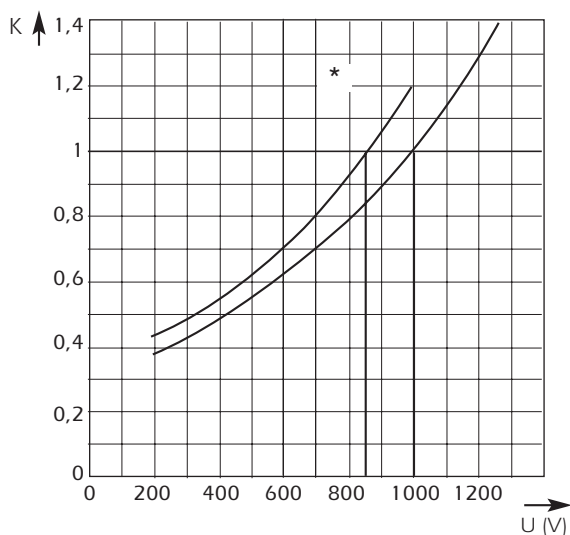

Left: Mean curve indicating variation of total  $I^2t$  ( $I^2t_t$ ) and total operating time  $T_t$  in accordance with working voltage  $U$ .

Example:  
Fuse 350 A in size 70.  
 $I_p = 10\,000\text{ A}$   $U = 1100\text{ V}$

At 1000 V  
 $I^2t_t = 115\,000\text{ A}^2\text{s}$   $T_t = 7\text{ ms}$

At 1100 V  
 $I^2t_t = 115\,000 \times 1.13 = 130\,000\text{ A}^2\text{s}$   
 $T_t = 7 \times 1.13 = 7.9\text{ ms}$

\* curve for fuses with  $I^2t$  published at 850VAC

### Dissipated power

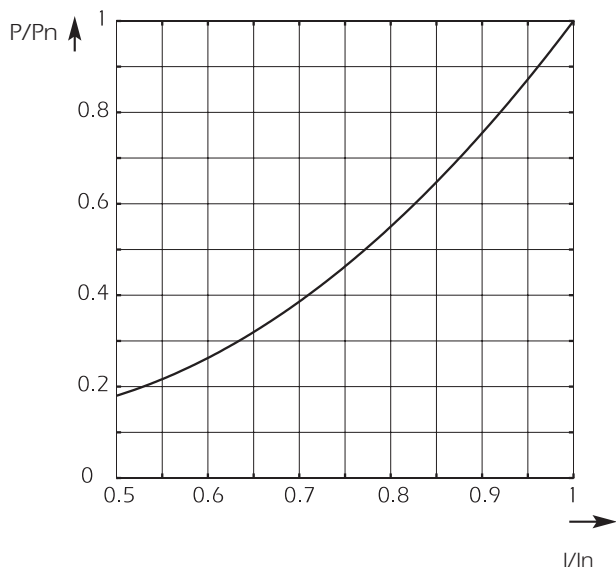

Above left: Curve enabling calculation of dissipated power  $P$  by a fuse rated  $I_{Nr}$  as a function of the RMS current  $I$ , in multiples of  $I_{Nr}$ , in steady state.

### Arc voltage

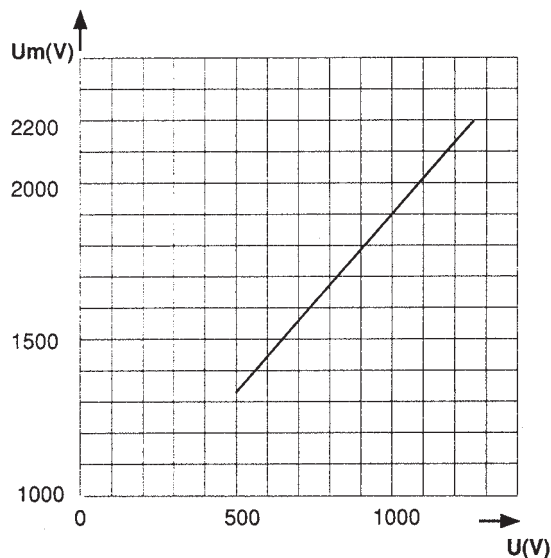

Above right: Curve indicating peak arc voltage  $U_m$  which may appear across fuse terminals as a function of working voltage  $U$  at  $\cos \varphi = 0.15$





## Protistor® Square-body Fuses PSC aR sizes 7x - 650 V to 1300 VAC Curves set

### Size 70

#### Cut-off characteristics

Curves indicating for each rated current the peak value  $I_C$  that the current may reach as a function of the prospective fault current  $I_p$ .

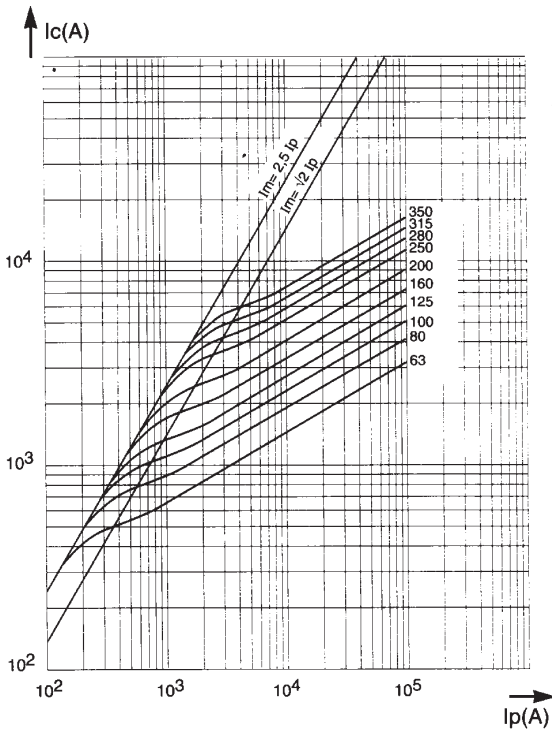

#### Time-current characteristics

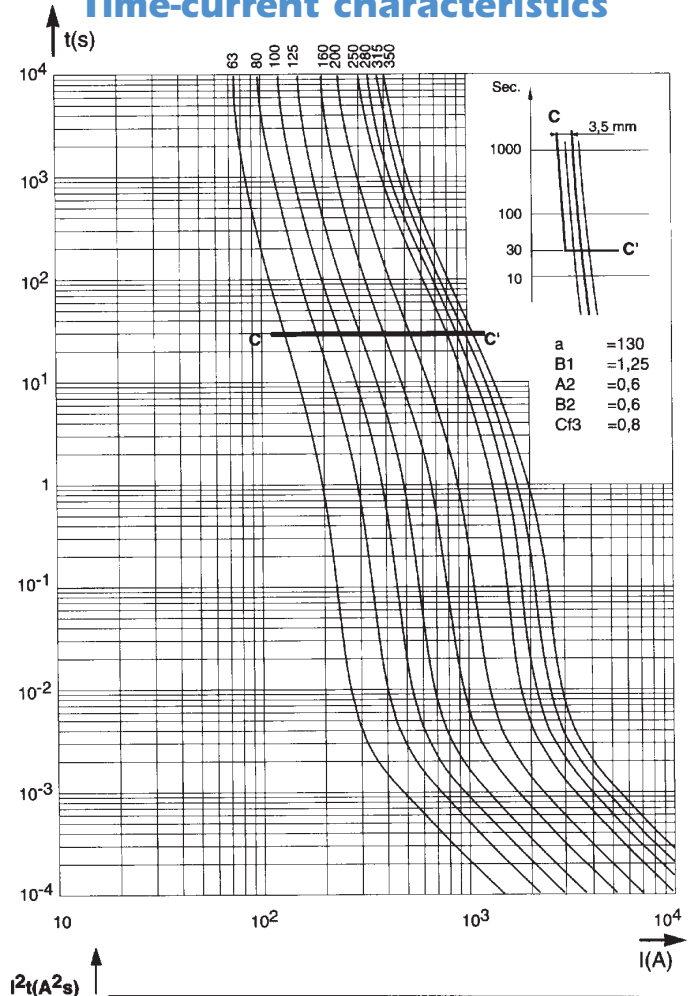

#### Time-current characteristics

- Curves indicating pre-arcing time for each rated current as a function of RMS value of pre-arcing current  $I$ .
- Tolerances on this current  $\pm 8\%$ .
- Beyond 30 sec, small overloads must be eliminated by another device.
- Curve CC' represents the maximum times taken by the associated device to clear small overloads; only its horizontal line is represented. Its oblique line must be plotted according to sketch, top right corner.
- The intersection of the fuse and CC' curves indicates the minimum breaking current  $I_{pm}$  of the fuse.

#### Maximum values of total operating $I^2t$ and total operating times

Horizontal curves indicating the maximum values of total operating  $I^2t$  ( $I^2t_t$ ) as function of the prospective current  $I_p$  at 1000V or 850 V(\*),  $\cos \varphi = 0.15$ .  
The oblique lines indicate the corresponding total operating time  $T_t$ , with pre-arcing time in brackets.

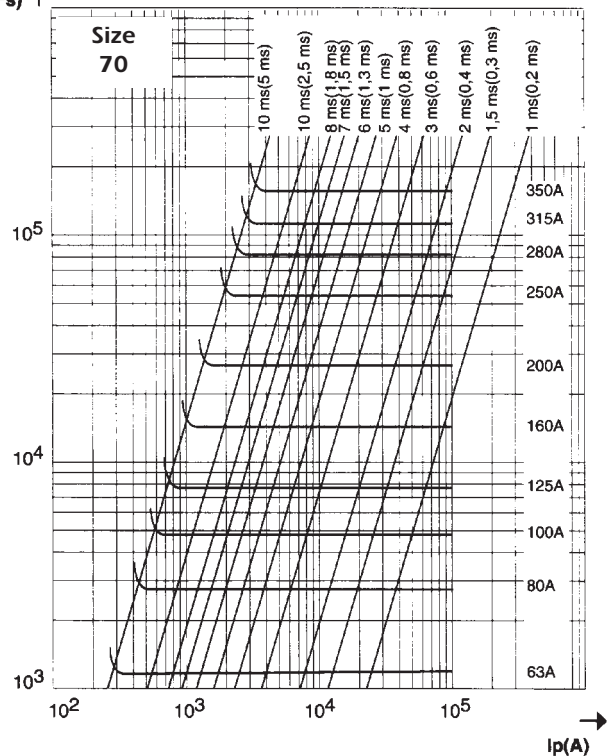

## Protistor® Square-body Fuses PSC aR sizes 7x - 650 V to 1300 VAC Curves set

### Cut-off characteristics

Curves indicating for each rated current the peak value  $I_C$  that the current may reach as a function of the prospective fault current  $I_p$ .

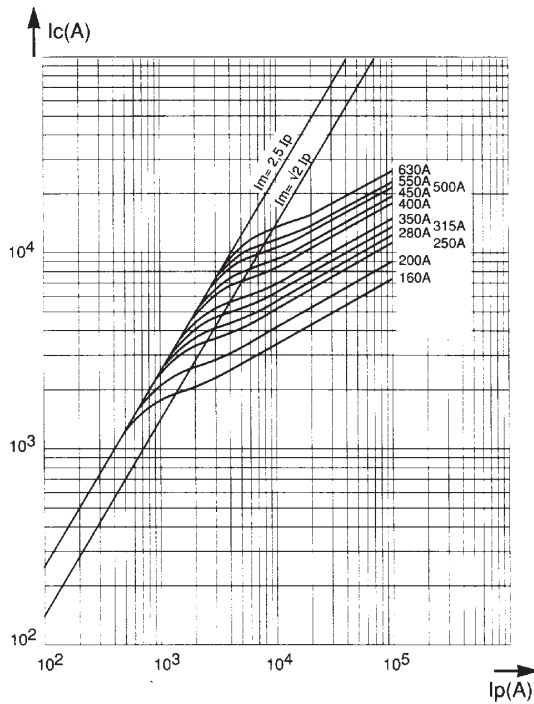

### Time-current characteristics

Curves indicating pre-arcing time for each rated current as a function of RMS value of pre-arcing current  $I$ .

- Tolerances on this current  $\pm 8\%$ .
- Beyond 30 sec, small overloads must be eliminated by another device.
- Curve CC' represents the maximum times taken by the associated device to clear small overloads; only its horizontal line is represented. Its oblique line must be plotted according to sketch, top right corner.
- The intersection of the fuse and CC' curves indicates the minimum breaking current  $I_{pm}$  of the fuse.

### Maximum values of total operating $I^2t$ and total operating times

Horizontal curves indicating the maximum values of total operating  $I^2t$  ( $I^2t_t$ ) as function of the prospective current  $I_p$  at 1000V or 850 V(\*),  $\cos \varphi = 0.15$ .

The oblique lines indicate the corresponding total operating time  $T_t$  with pre-arcing time in brackets.

### Size 71

### Time-current characteristics

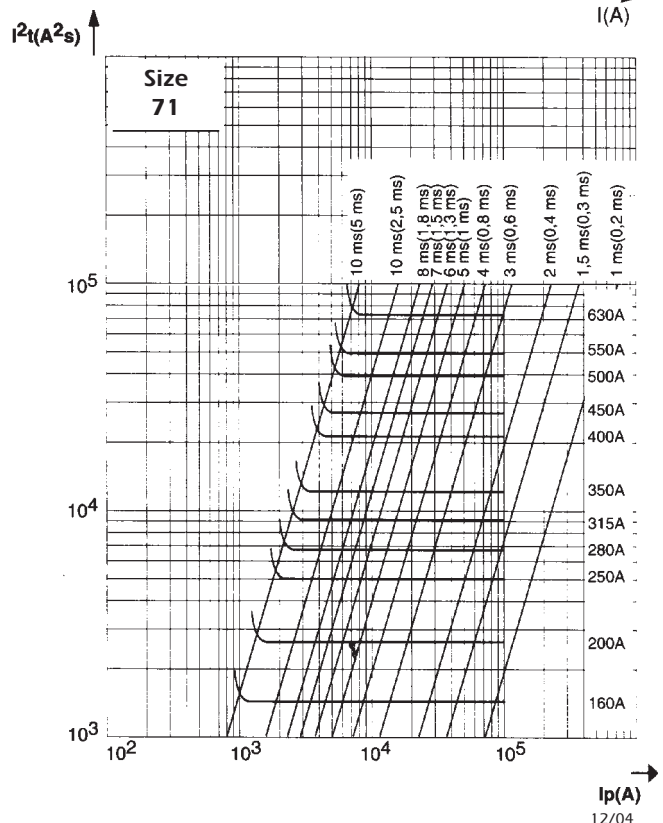
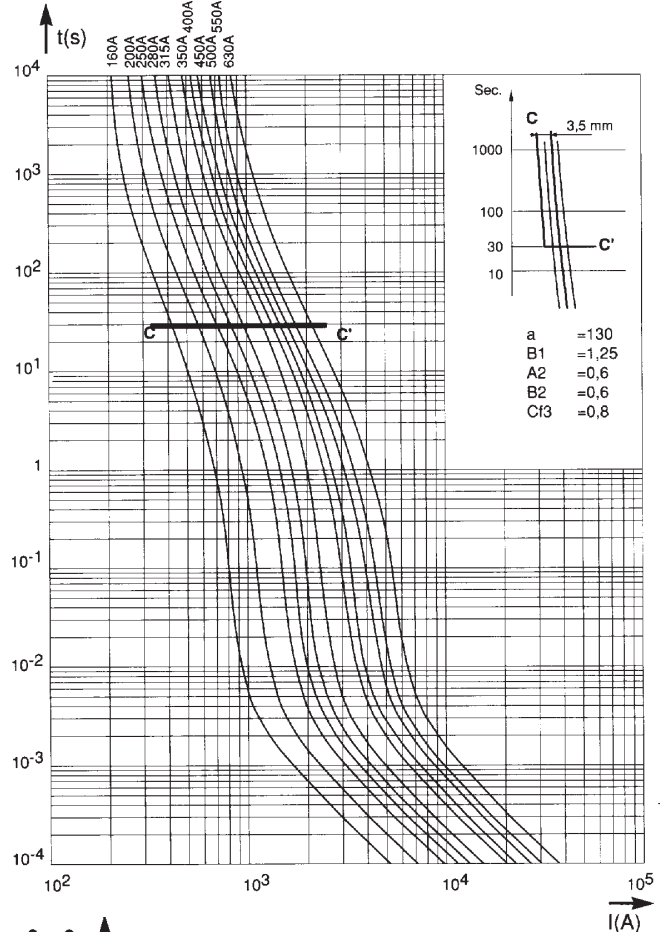



## Protistor® Square-body Fuses PSC aR sizes 7x - 650 V to 1300 VAC Curves set

### Size 72

#### Cut-off characteristics

Below, right: Curves indicating for each rated current the peak value  $I_C$  that the current may reach as a function of the prospective fault current  $I_p$ .

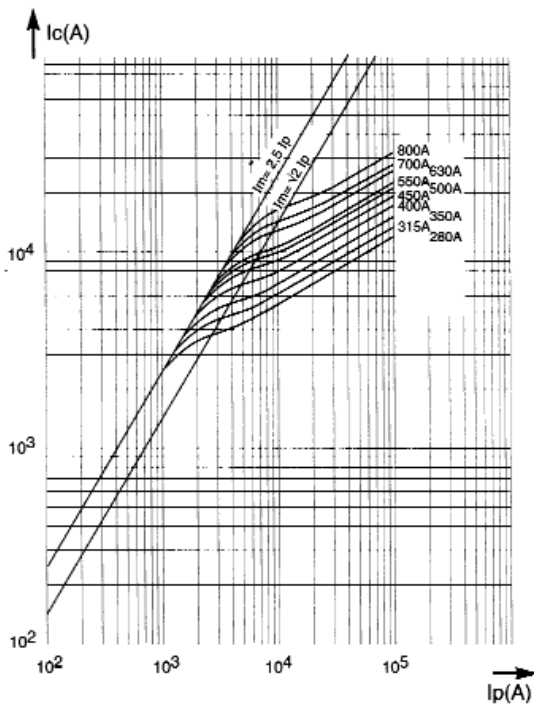

#### Time-current characteristics

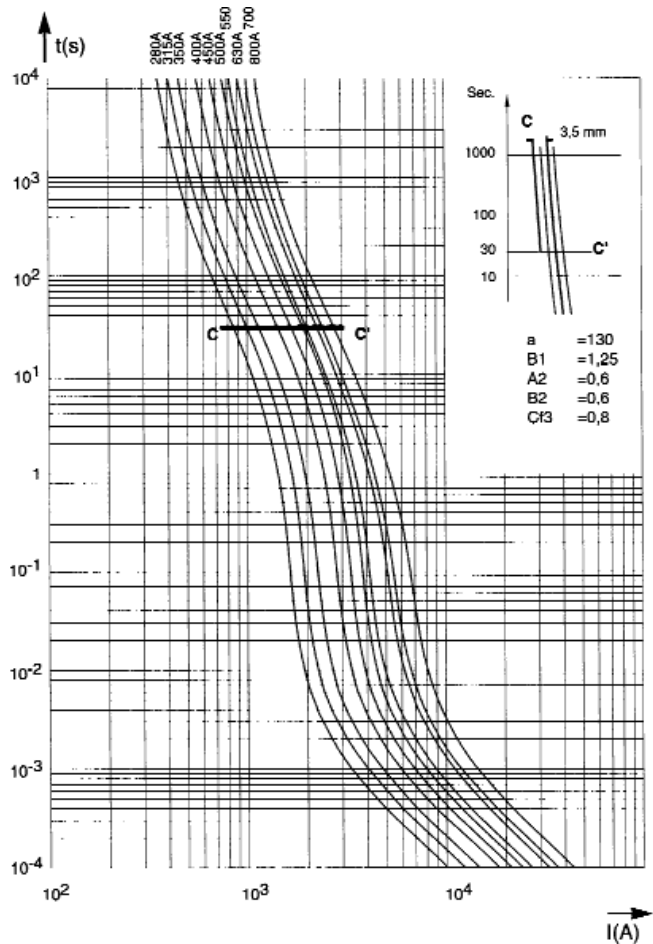

#### Time-current characteristics

Above, left: Curves indicating pre-arcing time for each rated current as a function of RMS value of pre-arcing current  $I$ .

- Tolerances on this current  $\pm 8\%$ .
- Beyond 30 sec, small overloads must be eliminated by another device.
- Curve CC' represents the maximum times taken by the associated device to clear small overloads; only its horizontal line is represented. Its oblique line must be plotted according to sketch, top right corner.
- The intersection of the fuse and CC' curves indicates the minimum breaking current  $I_{pm}$  of the fuse.

#### Maximum values of total operating $I^2t$ and total operating times

Left: Horizontal curves indicating the maximum values of total operating  $I^2t$  ( $I^2t_t$ ) as function of the prospective current  $I_p$  at 1000V or 850 V(\*),  $\cos \varphi = 0.15$ .

The oblique lines indicate the corresponding total operating time  $T_t$ , with pre-arcing time in brackets.

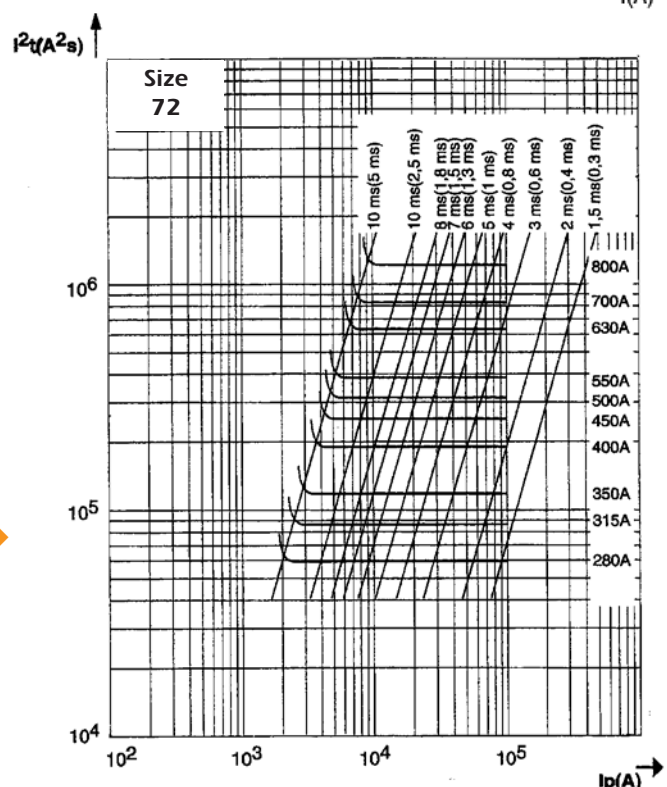



## Protistor® Square-body Fuses PSC aR sizes 7x - 650 V to 1300 VAC Curves set

Size 73

### Cut-off characteristics

Curves indicating for each rated current the peak value  $I_C$  that the current may reach as a function of the prospective fault current  $I_p$ .

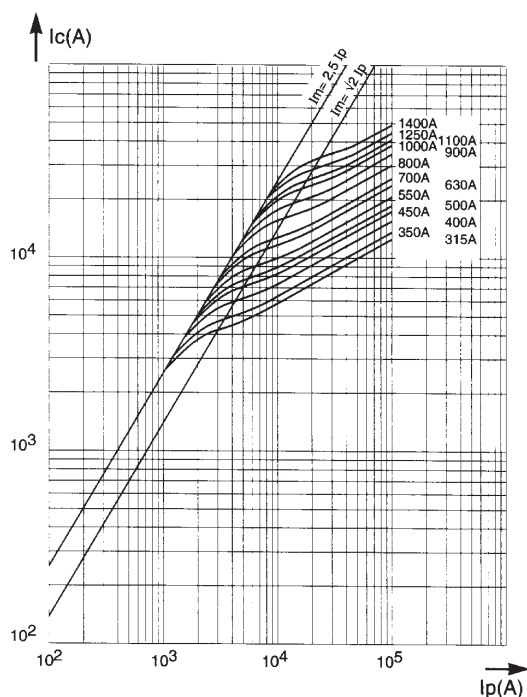

### Time-current characteristics

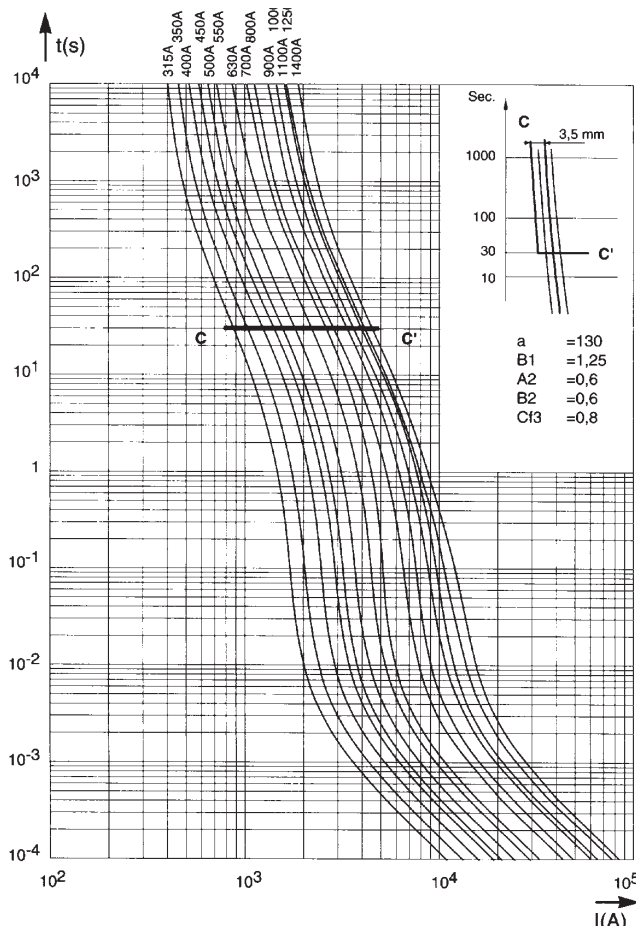

### Time-current characteristics

Curves indicating pre-arcing time for each rated current as a function of RMS value of pre-arcing current  $I$ .

- Tolerances on this current  $\pm 8\%$ .
- Beyond 30 sec, small overloads must be eliminated by another device.
- Curve CC' represents the maximum times taken by the associated device to clear small overloads; only its horizontal line is represented. Its oblique line must be plotted according to sketch, top right corner.
- The intersection of the fuse and CC' curves indicates the minimum breaking current  $I_{pm}$  of the fuse.

### Maximum values of total operating $I^2t$ and total operating times

Horizontal curves indicating the maximum values of total operating  $I^2t$  ( $I^2t_t$ ) as function of the prospective current  $I_p$  at 1000V or 850 V(\*),  $\cos \varphi = 0.15$ .

The oblique lines indicate the corresponding total operating time  $T_t$  with pre-arcing time in brackets.

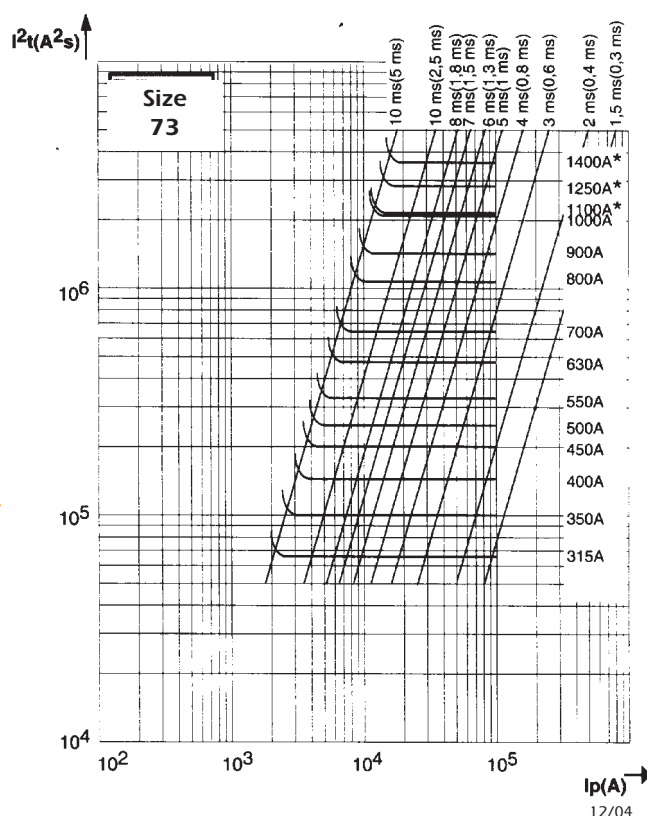

# Semiconductor (AC) fuses



## Protistor® Square-body Fuses PSC aR sizes 7x - 650 V to 1300 VAC Curves set

### Size 2x72

#### Cut-off characteristics

Curves indicating for each rated current the peak value  $I_C$  that the current may reach as a function of the prospective fault current  $I_p$ .

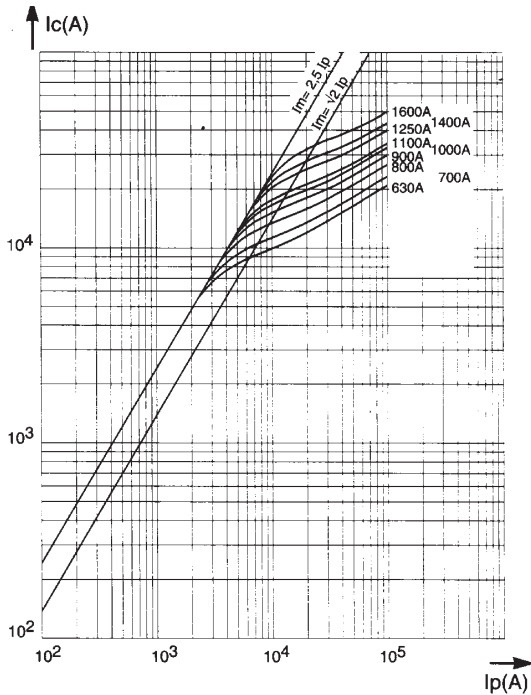

#### Time-current characteristics

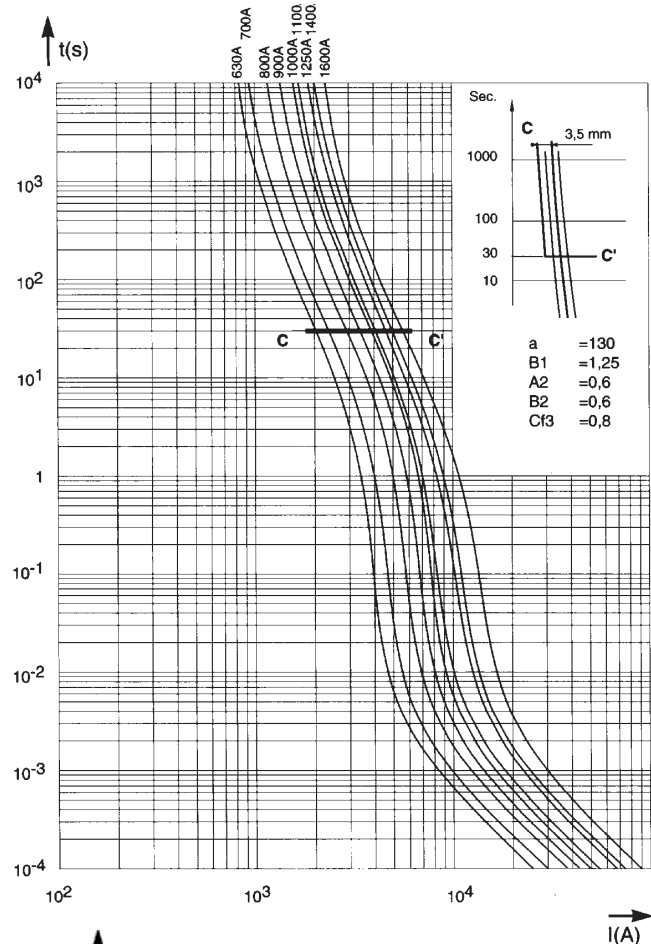

#### Time-current characteristics

Curves indicating pre-arcing time for each rated current as a function of RMS value of pre-arcing current  $I$ .

- Tolerances on this current  $\pm 8\%$ .
- Beyond 30 sec, small overloads must be eliminated by another device.
- Curve CC' represents the maximum times taken by the associated device to clear small overloads; only its horizontal line is represented. Its oblique line must be plotted according to sketch, top right corner.
- The intersection of the fuse and CC' curves indicates the minimum breaking current  $I_{pm}$  of the fuse.

#### Maximum values of total operating $I^2t$ and total operating times

Horizontal curves indicating the maximum values of total operating  $I^2t$  ( $I^2t_t$ ) as function of the prospective current  $I_p$  at 1000V or 850 V(\*),  $\cos \varphi = 0.15$ .

The oblique lines indicate the corresponding total operating time  $T_t$ , with pre-arcing time in brackets.

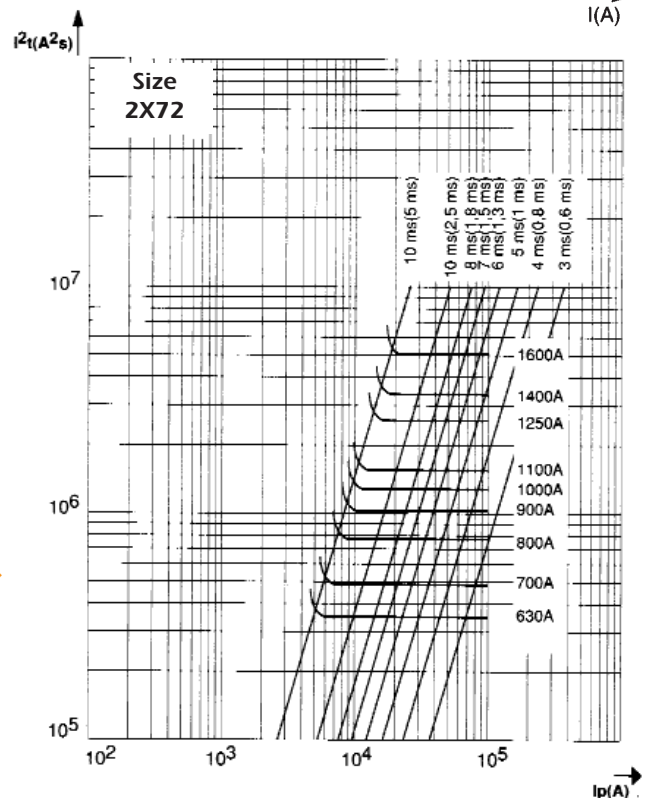

# Semiconductor (AC) fuses

## Protistor® Square-body Fuses PSC aR sizes 7x - 650 V to 1300 VAC Curves set

### Cut-off characteristics

Curves indicating for each rated current the peak value  $I_C$  that the current may reach as a function of the prospective fault current  $I_p$ .

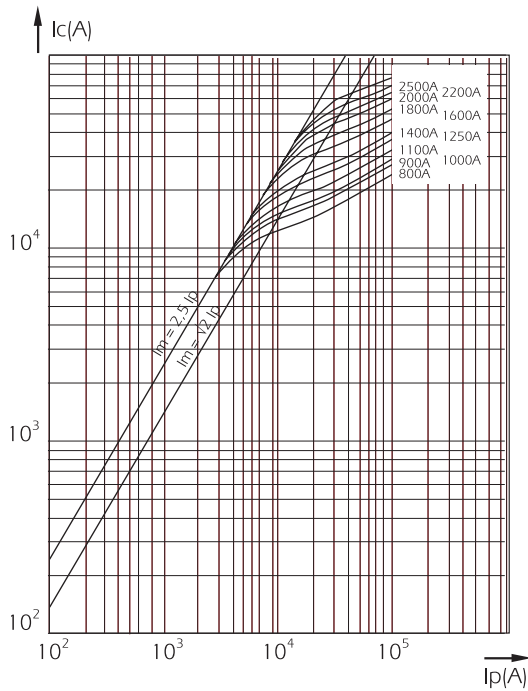

### Time-current characteristics

Curves indicating pre-arcing time for each rated current as a function of RMS value of pre-arcing current  $I$ .

- Tolerances on this current  $\pm 8\%$ .
- Beyond 30 sec, small overloads must be eliminated by another device.
- Curve CC' represents the maximum times taken by the associated device to clear small overloads; only its horizontal line is represented. Its oblique line must be plotted according to sketch, top right corner.
- The intersection of the fuse and CC' curves indicates the minimum breaking current  $I_{pm}$  of the fuse.

### Maximum values of total operating $I^2t$ and total operating times

Horizontal curves indicating the maximum values of total operating  $I^2t$  ( $I^2t_t$ ) as function of the prospective current  $I_p$  at 1000V or 850 V(\*),  $\cos \varphi = 0.15$ .

The oblique lines indicate the corresponding total operating time  $T_t$ , with pre-arcing time in brackets.

Size 2x72

### Time-current characteristics

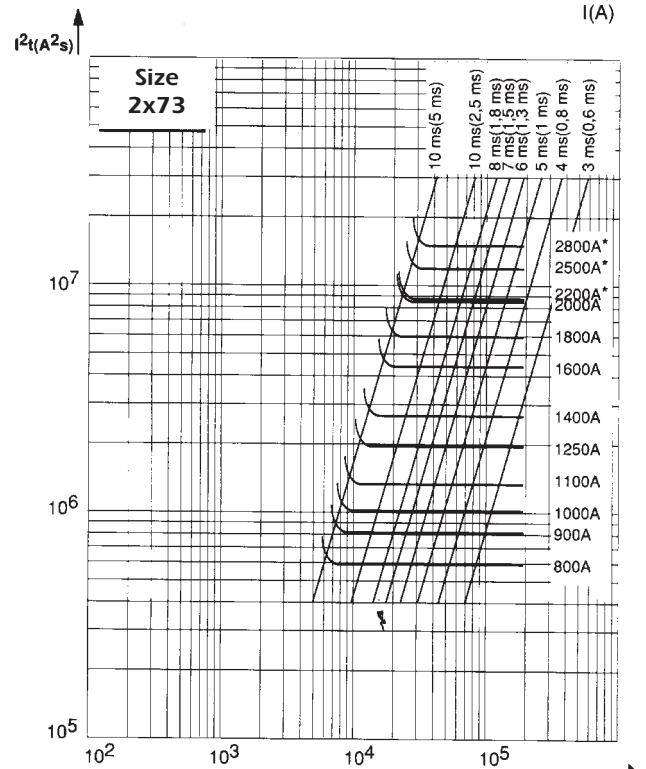
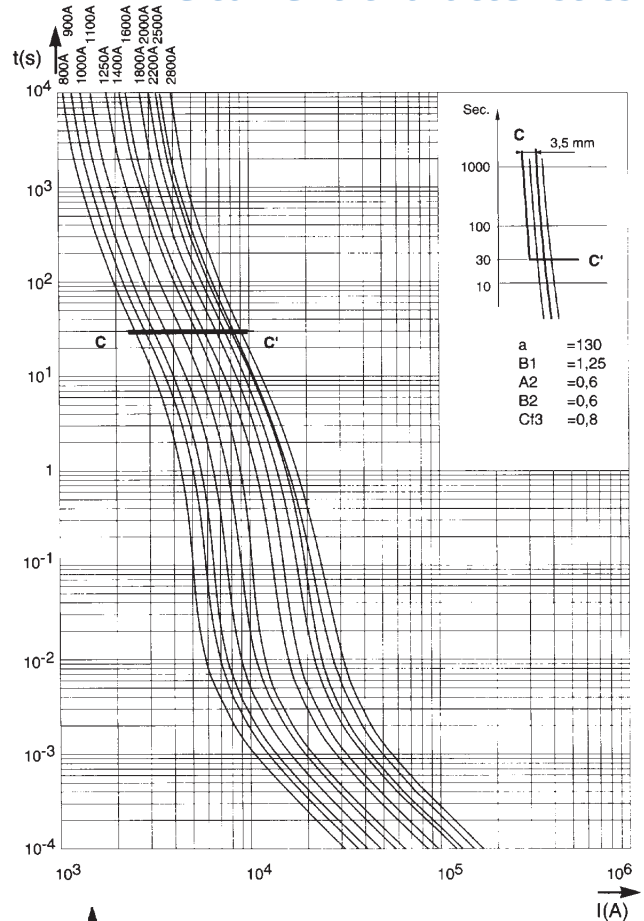



## Protistor® Square-body Fuses PSC aR sizes 7x - 650 V to 1300 VAC Curves set

### DC working voltage possibilities

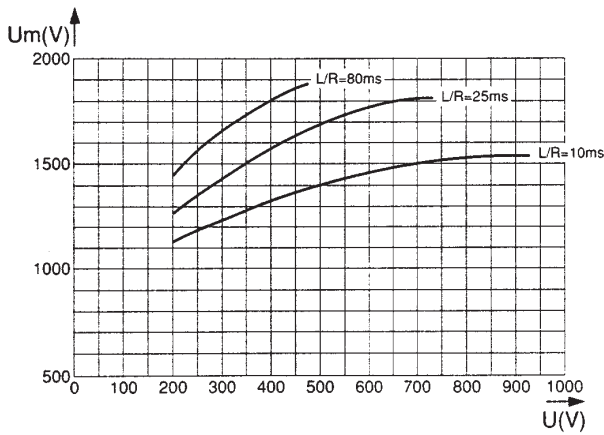
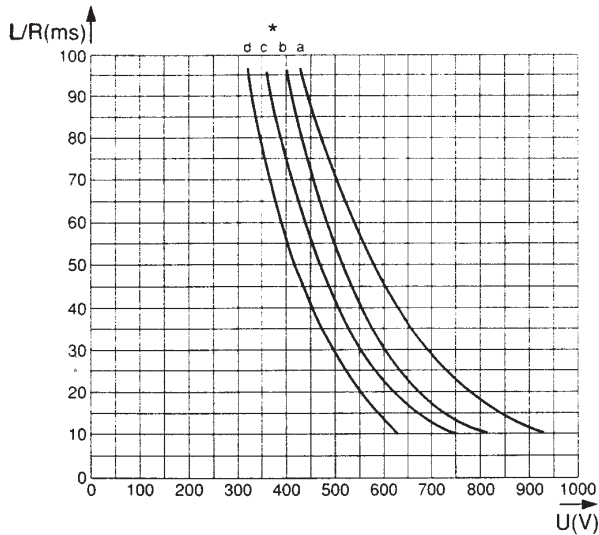

Top: Curves indicating the maximum time constant  $L/R$  of the fault path as a function of the DC voltage  $U$ , for the rated currents in the sizes indicated in the table.

$I_{pm}$  (1) values indicate the minimum breaking current in Amperes (A).

Remark: When the fault current  $di/dt$  is very large, this condition can be exceeded. It is the case for faults occurring in voltage commutated inverters.

Below: Curves indicating peak arc voltage  $U_m$  which may appear across fuse terminals as a function of the DC working voltage  $U$ , for various time constant  $L/R$  of fault path.

Rated current $I_N$ (A)	Curves (*) and $I_{pm}$ (1) corresponding to the rating					
	70 * $I_{pm}$ (A)	71 * $I_{pm}$ (A)	72 * $I_{pm}$ (A)	73 * $I_{pm}$ (A)	2x72 * $I_{pm}$ (A)	2x73 * $I_{pm}$ (A)
63	a 270					
80	a 400					
100	a 520					
125	a 700					
160	a 950	a 950				
200	a 1300	a 1300				
250	a 1800	a 1800				
280	b 2200	a 2000	a 1800			
315	b 2600	a 2300	a 2200	a 2000		
350	c 3000	a 2700	a 2600	a 2400		
400		b 3500	a 3200	a 3000		
450		b 4000	a 3800	a 3500		
500		c 4800	a 4600	a 3900		
550		c 5200	b 5000	a 4400		
630		c 6400	b 6200	a 5300	a 4400	
700			c 6800	a 6000	a 5200	
800			c 8000	b 8000	a 6400	a 6000
900				b 9000	a 7600	a 7000
1000				c 11000	a 9200	a 7800
1100				c 12000	b 10000	a 8800
1250				c 13500	b 12400	a 10600
1400				c 15000	c 13600	a 12000
1600					c 16000	b 16000
1800						b 18000
2000						c 22000
2200						c 24000
2500						d 27000
2800						d 30000

## Protistor® Square-body Fuses PSC aR sizes 3x - 450V to 700 VAC Microswitches PSC 3x & 7x

- MICROSWITCH SYSTEMS ADAPTED TO THE FOLLOWING FERRAZ SHAWMUT FUSES ONLY:
- PSC sizes 30, 31, 32, 33, 2x32, 2x33 / 70, 71, 72, 73, 272, 273 except plain blades
- PSC LR sizes 33, 233, 73, 273
- PERMANENT INDICATION OF FUSE STATE: CONDUCTIVE  
BLOWN
- MANUAL RESETTING
- STANDARD AND LOW ELECTRICAL LEVEL WITH DIFFERENT INSULATION LEVELS
- BS TYPE FOR USE IN CORROSIVE ATMOSPHERE
- MS 3V 1-5 UR AND MS 7V 1-5 UR TYPE UL ARE RECOGNIZED



MS 7V 1-5

### Main Characteristics

Code	AC Insulation voltage rating (***)	Positive operating voltage/current	Current rating	Current	Breaking Capacity						AC voltage withstand test (*)	Impulse voltage test Uimp1.2/50 µs (**)	Fire class according to UL 94
					Non inductive circuit			Inductive circuit : L/R = 25ms					
					30V	110V	250V	30V	110V	250V			
MS 3V 1-5 MS 3V 1-5 UR	1000 V	20 V 50 mA	10 A	50/60 Hz	10 A	10 A	10 A	10 A	10 A	10 A	8,5 kV	14 kV	H.B
MS 7V 1-5 MS 7V 1-5 UR				DC	8 A	0,4 A	0,2 A	4 A	0,2 A	0,1 A			
MS 3V 1-5 BS MS 3V 1-9 BS	1000 V	10 V 10 mA	3 A	50/60 Hz	3 A	3 A	3 A	2 A	1 A	1 A	8,5 kV	14 kV	
MS 7V 1-5 BS MS 7V 1-9 BS				DC	3 A	0,5 A	0,25 A	3 A	0,2 A	0,1 A			
MS 3V 1-5 ET MS 7V 1-5 ET	1000V 1500V	10 V 10 mA	3 A	50/60 Hz	3 A	3 A	3 A	2 A	1 A	1 A	8,5 kV	14 kV	
				DC	3 A	0,5 A	-	2 A	0,2 A	-			

\* Between power circuit and microswitch terminals as per IEC 60 and 694 and NFC 64010 (50/60 Hz 1 min duration in dry air)

\*\* Between power circuit and microswitch terminals Uimp: impulse voltage as per IEC 60947-1

\*\*\* Between power circuit and microswitch terminals

**Warning:** microswitch systems exclusively designed for FERRAZ SHAWMUT.  
PSC Fuses fitted a patented trip-indicator, saving use of EDV





## Protistor® Square-body Fuses PSC aR sizes 3x - 450V to 700 VAC Microswitches for PSC 3x &7x

### Indication systems for PSC Fuse sizes 30 to 73 MS 3V...

These patented indication systems are exclusively hand resettable.

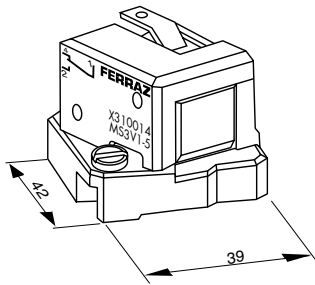

(fig. 1)

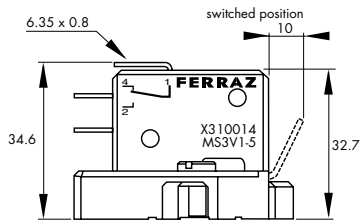

Fuse size	Designation	Ref. Number	Indication style	Weight (g)	Pack.	Catalog Number
30, 31 32, 33	MS 3V 1-5 (fig.1)	X310014	Standard NO-NC	34	3 pieces	MS3 V1-5
	MS 3V 1-5 UR	Y310038				MS3 V1-5UR
	MS 3V 1-5 BS (3)	K310013	Low level NO-NC	34	3 pieces	MS3-V1-5BS
	MS 3V 1-9 BS (4)	P310011	Double pole Low level	44	3 pieces	MS3V1-9BS
	MS 3V 1-5 ET (fig.2)	S310009	Low level NO-NC IP 50 (9)	34	3 pieces	MS3V1-5 ETANCHE

(3) Same as fig.1

(4) Same dimensions as figure 1 but with 2 microswitches side by side

(9) Watertightness class

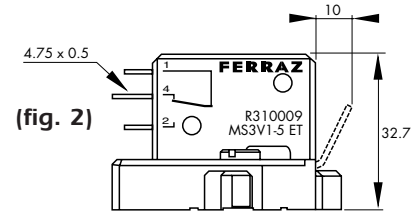

(fig. 2)

### MS 7V...

Fuse size	Designation	Ref. Number	Indication style	Weight (g)	Pack.	Catalog Number
70, 71 72, 73	MS 7V 1-5 (fig.5)	J310002	Standard NO-NC	45	3 pieces	MS7 V1-5
	MS 7V 1-5 UR	Z310039				MS7 V1-5UR
	MS 7V 1-5 BS (3)	K310003	Low level NO-NC	45	3 pieces	MS7-V1-5BS
	MS 7V 1-9 BS (4)	P310007	Double pole Low level	55	3 pieces	MS7V1-9BS
	MS 7V 1-5 ET (fig.6)	S310010	Low level NO-NC IP 50 (9)	55	3 pieces	MS7V1-5 ETANCHE

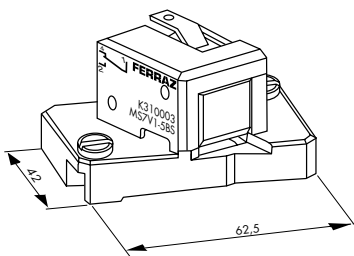

(fig. 5)

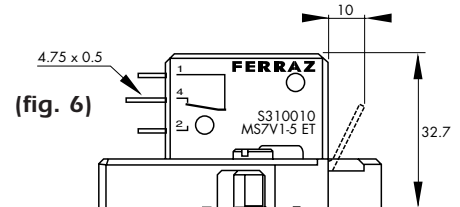
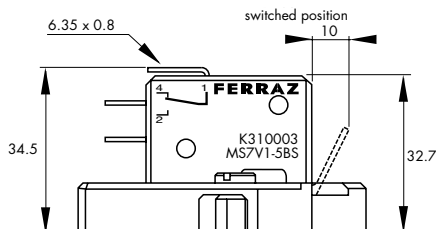

(fig. 6)

(7) Same as fig. 5

(8) Same dimensions as figure 5 but with 2 microswitches side by side

(9) Watertightness class



**Warning:** Microswitch systems exclusively designed for FERRAZ SHAWMUT PSC fuses fitted with a patented trip-indicator, saving use of EDV.

# Semiconductor (AC) fuses

## Protistor® Square-body Fuses PSC gR sizes 7x - 690 VAC Metric-studs

### Metric studs for threaded terminal fuses



Type and fuse size	Designation	Ref. Number	Unit weight (g)	Pack.	Catalog Number
 Sizes 0 and 1	HC stud pair M8x30 & M8x35	S098801	23	6 pairs	STU M8x30 M8x35
	Size 2 HC stud pair M10x30 & M10x50	T098802	40	6 pairs	STU M10x30 M10x50
	Size 3 HC stud pair M12x35 & M12x50	V098803	60	6 pairs	STU M12x35 M12x50
 Size 2	HC stud pair M10x50	W098804	45	6 pairs	STU M10x50
	Size 3 HC stud pair M12x50	X098805	45	6 pairs	STU M12x50

We recommend the use of studs, whose quality is suited to all FERRAZ SHAWMUT square-body fuses with terminals

### Stud mounting

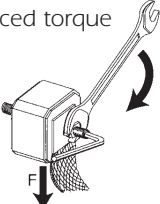
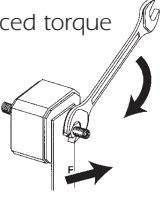
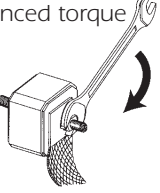
Torque type	Stud type	Maximum stud tightening torque (Nm) (1)	Maximum nut tightening torque (Nm) (1)
Balanced torque 	M8x30 & M8x35	10	13.5
	M10x30 & M10x50	15	26
	M12x35 & M12x50	15	46
Balanced torque 	M8x30 & M8x35	10	13.5
	M10x30 & M10x50	15	26
	M12x35 & M12x50	15	46
Unbalanced torque 	M8x30 & M8x35	10	13.5
	M10x30 & M10x50	15	26
	M12x35 & M12x50	15	46

(1) Factory limit on torque at 20°C ambient: +0, -2Nm; except on 46Nm value (+0, -4Nm)